

OIL PUMP Models: Selected part # 6481800301. OIL PUMP. Fits Mercedes E 320 CDI 2005, 2006.

855.984.3207 E-Mail Us About Us Testimonials

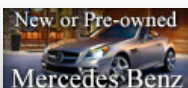

Mercedes-Benz of South Atlanta



Your Cart is empty: \$0.00

CART

Roadsters and Supercars Sedans, Coupes and Wagons SUVs and Crossovers All Mercedes Parts

Search Words or Part Numbers

Search

Home > OIL PUMP

My Profile

G+ 96

f Like

4.7k

Continue Shopping

### OIL PUMP

Models:  
E 320 CDI 05-06

Chassis:  
211026/63T

Engines:  
R6 DIESEL ENGINE  
648.961

Automatic Transmissions:  
AUTOMATIC FIVE-SPEED TRANSMISSION WITH CONVERTER



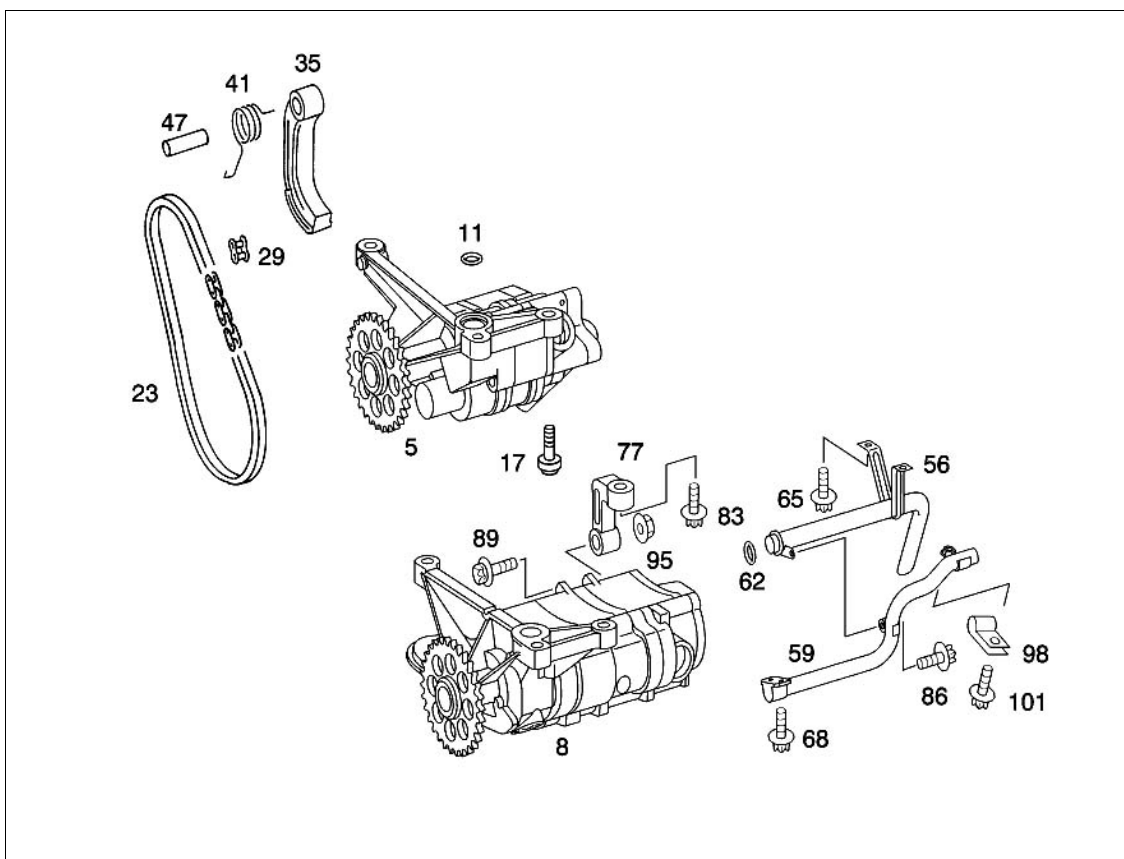







Manual Transmissions:



No Vehicle Selected

Change Vehicle

008	<b>OIL PUMP.</b> Required: 001 3002025420030319	\$474.88	6481800301 >
011	<b>SEAL RING.</b> Required: 001 OIL PUMP TO CRANKCASE	\$2.90	0199978048 >
017	<b>BOLT. SCREW.</b> Required: 003 OIL PUMP TO CRANKCASE	\$2.00	0019900314 >

023	<b>ROLLER CHAIN.</b> Required: 001	\$51.00	0039977494 >	
029	<b>CHAIN LOCK LINK.</b> Required: 001	\$3.70	0009973298 >	
035	<b>CLAMPING BRACKET.</b> Required: 001 OIL PUMP CHAIN TIGHTENER	\$13.00	1111800071 >	
041	<b>SPRING.</b> Required: 001 OIL PUMP CHAIN TIGHTENER	\$4.50	6019930120 >	
047	<b>DOWEL PIN. PIN.</b> Required: 001 OIL PUMP CLAMPING BRACKET BEARING	\$3.70	1119970510 >	
056	<b>INTAKE MANIFOLD.</b> Required: 001 AT CYLINDER CRANKCASE	\$52.00	6481860415 >	
059	<b>OIL LINE.</b> Required: 001 (RETURN LINE)	\$92.00	6481880120 >	
062	<b>O-RING.</b> Required: 001 INTAKE MANIFOLD TO CYLINDER CRANKCASE	\$3.20	0279973848 >	
068	<b>HEXALOBULAR BOLT. SCREW.</b> Required: 002 SUCTION PIPE TO OIL PUMP	\$1.70	000000001462 >	
077	<b>BRACKET.</b> Required: 001 OIL PUMP TO CRANKCASE	\$10.00	6471810095 >	
089	<b>HEXALOBULAR BOLT. SCREW.</b> Required: 001 OIL PUMP TO BRACKET	\$2.50	910143006007 >	
065	<b>BOLT. HEXALOBULAR BOLT. SCREW.</b> Required: 002 INTAKE MANIFOLD TO CYLINDER CRANKCASE		910143006000 >	PRODUCT NLA
083	<b>HEXALOBULAR BOLT. SCREW.</b> Required: 001 BRACKET MOUNTING		000000001116 >	PRODUCT NLA
086	<b>HEXALOBULAR BOLT. SCREW.</b> Required: 001 OIL PUMP TO BRACKET		910143006002 >	PRODUCT NLA
095	<b>HEXAGON NUT. NUT.</b> Required: 001 OIL PUMP TO BRACKET		910112006003 >	PRODUCT NLA
098	<b>CLAMP. CLIP.</b> Required: 001 INTAKE MANIFOLD TO RETURN LINE		916016022206 >	PRODUCT NLA
101	<b>BOLT. HEXALOBULAR BOLT. SCREW.</b> Required: 001 CLAMP MOUNTING		910143006000 >	PRODUCT NLA

Please note that this catalog does not represent or guarantee the availability of the parts listed. Prices are subject to change. While every reasonable effort is made to ensure the accuracy of this data, we are not responsible for any errors or omissions contained on these pages.

 Please verify any information in question with a sales representative. While every reasonable effort is made to ensure the accuracy of this data, we are not responsible for any errors or omissions contained on these pages. Please verify any information in question with a sales representative.

